

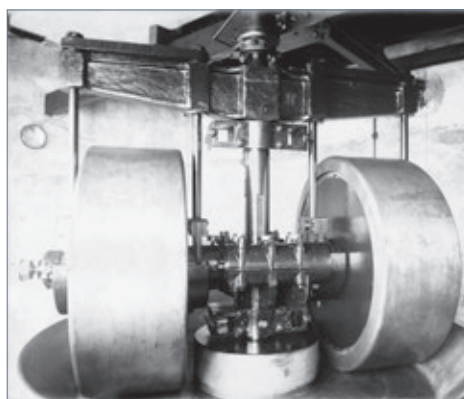

SPECIAL PRODUCTS



SINCE 1920



Explosia a.s.

Explosia a.s. is the traditional and most important Czech manufacturer of explosives with a history dating to 1920, when „Československá akciová továrna na látky výbušné“ (Czechoslovak joint-stock company for the production of explosive substances) was founded in Semtín, near Pardubice. The history of the name Explosia a.s. dates back to 1934 (until 1946) and the tradition was renewed in 1998.

Explosia a.s. is 100% in the ownership of the Czech Republic; it is an independent commercial company with a significant position on the market of industrial.

Explosia a.s. is an internationally famous and important manufacturer of industrial explosives and smokeless powders exported to a number countries in the European Union and outside it.

Explosia a.s. has available production and storage capacities serviced by qualified personnel, which makes it possible to offer wide line of special explosive products.



Research and development in the field of explosives - special products



The Research Institute of Industrial Chemistry (VÚPCH), founded in 1954 is the part of Explosia a.s. This institute ensures research and development in the field of explosives and ammunition not only for Explosia a.s., but also for other partners within the Czech Republic and abroad. Apart from research and development, whose results are intended both for industrial applications and the military sphere, VÚPCH offers services in the field of analytical chemistry, testing and safety engineering for explosives and ammunition, small tonnage production of new energy materials and special explosives and the production of pyrotechnic components for aircraft rescue systems.



Quality control management

The quality control system was introduced in the company in 1998 in the extent corresponding to the ISO 9001 standard. Since 2003, after successfully passing the re-certification audit, Explosia a.s. has been the holder of the Certificate according to EN ISO 9001:2000 system standard and since 2004, the holder of a Certificate of quality system conformity with the AQAP 2110 requirements. Another recertification audit in accordance with the ISO 9001 standard proceeded successfully in 2006.



CONTENS

ENERGETIC MATERIALS	5
SPECIAL PRODUCTS	8
LARGE-CALIBRE AMMUNITION	15
PYROTECHNICAL PRODUCTS	20
TESTING EQUIPMENT.....	22
RESCUE SYSTEMS FOR AIRCRAFT	24
ACCREDITED SERVICES	26



ENERGETIC MATERIALS

GZT

GUANIDINIUM-5,5'-AZOTETRAZOLATE

GZT is a yellow crystalline substance with high nitrogen content. It is used in gas generators (e.g. seat belt fasteners in a car), airbags and special fire extinguishing devices.

Classification:

Not classified.

Delivery quantity:

Laboratory and pilot plant preparation in limited quantities.

Properties	Limit values
Appearance	yellow powder
Purity	min. 98.5 %
Melting point	min. 243 °C
Ash	max. 0.15 %
Water content	max. 0.50 %

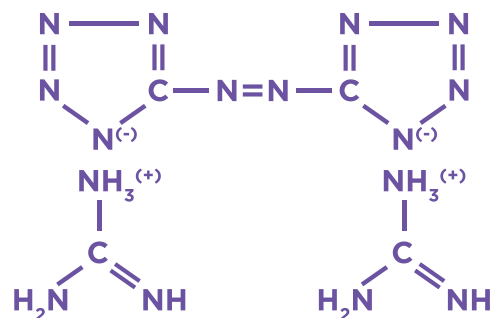

Molecular formula: C₄H₁₂N₁₆

CAS: unknown

Molecular weight: 284.24 g.mol⁻¹

TAGN

TRIAMINOGUANIDINE NITRATE

TAGN is a white crystalline substance used for the production of special single-base powders, propellants, nitrogen generators, and for pyrotechnic purposes.

Classification:

UN 0475 Substances, explosive, N.O.S. 1.1D

Delivery quantity:

Laboratory and pilot plant preparation in limited quantities.

Properties	Limit values
Appearance	white fine powder
Active ingredient content	99.5-100.0 %
Melting point	min. 212 °C
pH of 3% solution	5-7
Ash	max. 0.30 %

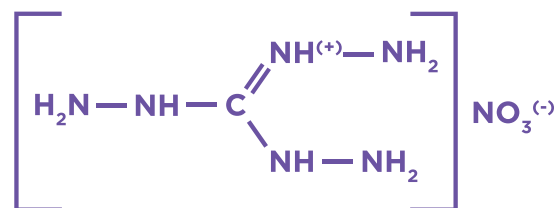

Molecular formula: CH₉N₇O₃

CAS: [4000-16-2]

Molecular weight: 167.13 g.mol⁻¹

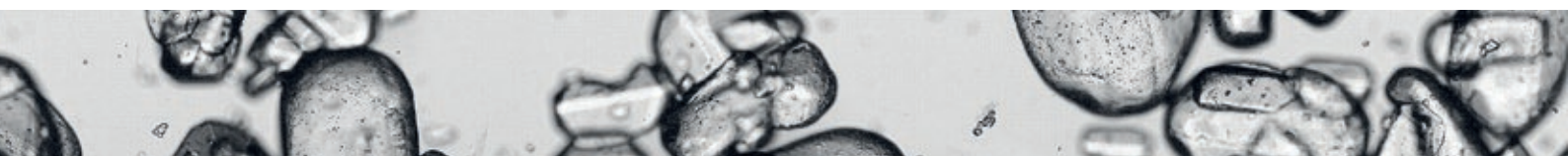

NTO

3-NITRO-1,2,4-TRIAZOL-5-ONE

NTO is a yellowish crystalline substance with reduced sensitivity to mechanical stimuli. It is used for the manufacture of special-purpose low-vulnerability ammunition.

Classification:

UN 0490 OXYNITROTRIAZOL 1.1D

Delivery quantity:

Laboratory and pilot plant preparation in limited quantities.

Properties	Limit values
Appearance	yellowish crystalline substance
Active ingredient content	min. 99.0%
Melting point	min. 268 °C
Moisture	max. 0.50%
Ash	max. 0.15%

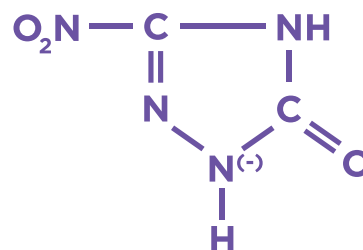

Molecular formula: $C_2H_2N_4O_3$

CAS: [932-64-9]

Molecular weight: 130.10 g.mol⁻¹

RDX-R

ROUNDED HEXOGEN

RDX-R is a white substance with spherical crystal shapes. It is used for special applications, e.g. as a component of thermostable detonators, detonating fuses and special paste explosives.

Classification:

UN 0072, CYKLOTRIMETHYLENE-TRINITRAMINE (CYKLONITE, HEXOGEN, RDX), wetted with not less than 15% water, by mass.

Delivery quantity:

Laboratory and pilot plant preparation in limited quantities.

Properties	Limit values
Appearance	white crystalline substance
Active ingredient content	min. 99.5%
Melting point (decomposition)	204 °C
Ash	max. 0.04%
Acidity	max. 0.02%
Insoluble residue	max. 0.01%
Moisture	max. 0.10%

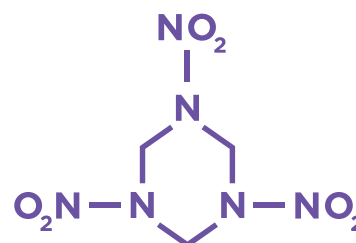

Molecular formula: $C_3H_6N_6O_6$

CAS: [121-82-4]

Molecular weight: 222.00 g.mol⁻¹





SPECIAL PRODUCTS

Semtex[®] RAZOR

FLEXIBLE LINEAR SHAPED CHARGES

Flexible, RDX and PETN based charges for special blasting works. Typical length 1m or 2m in various weights (length can be adjusted according to the requirement of customer).

The performance charge underwater is limited.

UN No.: 0288, Charges, shaped, flexible, linear, 1.1D

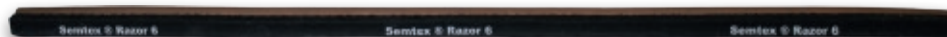

Parameter	Charge Type						
	RAZOR 6	RAZOR 10	RAZOR 15	RAZOR 20	RAZOR 25	RAZOR 30	RAZOR 40
Weight of explosive (g.m ⁻¹)	50.0	140.0	310.0	550.0	860.0	1,250.0	2,200.0
Total weight (g.m ⁻¹)	140.0	390.0	860.0	1,500.0	2,400.0	3,500.0	6,000.0
Performance on steel plate(mm)	min. 6.0	min. 10.0	min. 15.0	min. 20.0	min. 25.0	min. 30.0	min. 40.0
Width (mm)	18.0	28.0	42.0	56.0	68.0	80.0	100.0
Height (mm)	12.0	19.5	28.5	38.5	48.5	58.5	77.0
Tube radius (mm)	20.0	35.0	50.0	60.0	75.0	90.0	120.0
Plane radius (mm)	90.0	150.0	220.0	300.0	375.0	450.0	600.0

Semtex[®] RAZOR Booster

BOOSTER CHARGE

Designed especially for initiation of flexible linear shaped charges Semtex[®] RAZOR. This booster charge can be also used for initiation of other explosives, e.g. sheet charges Semtex[®] P1 SE M. The charge is, through its construction, adapted to boost initiation capacity of standard detonator.

UN No.: 0042, BOOSTERS without detonators, 1.1D



length
cca 3cm

Properties	Limit values
Explosive content (PETN)	88 ± 2%
Density	min. 1.48 g.m ⁻³
Detonation velocity	min. 7,400 m.s ⁻¹
DMNB content	min. 1.0 %
Application temperature	-20 - +50 °C
Priming	min. detonator No. 8
Mass	6.00 ± 0.25g



Semtex[®] PL SE M

SHEET EXPLOSIVE

Sheets of plastic explosive for special blasting works.

Typical dimension 400 x 200 x 3mm (dimensions can be adjusted according to the requirement of customer).

The product can be made on basis of PETN, RDX, PETN/RDX, minimal thickness of PETN version is 0.8mm, PETN/RDX version 2.0mm, RDX version 3.0mm.

UN No.: 0084, explosive, blasting, type D, 1.1D



Parameter	Typical analysis	Limit values
Explosive content (RDX, PETN)	88.0%	88.0 ± 3.0%
Density	1.56 g.cm ⁻³	min. 1.48 g.cm ⁻³
Vacuum test	0.20 cm ³ .g ⁻¹ .h ⁻¹ .20	max. 1.0 cm ³ .g ⁻¹ .h ⁻¹ .20
Detonation velocity	7,900 m.s ⁻¹	min. 7,400 m.s ⁻¹
DMNB content	1.1%	min. 1.0%

Semtex[®] PL SE M LCT

EXPLOSIVE TAPE CHARGES

Tapes of plastic explosive for special blasting works.

Typical length 1m in various weights (length can be adjusted according to the requirement of customer).

The standard length of the product is 1 metre or 2 metres.

UN No.: 0084, explosive, blasting, type D, 1.1D



Parameter	Charge Type			
	LCT 20	LCT 55	LCT 205	LCT 740
Mass of one meter	min. 20 g	min. 55 g	min. 205 g	min. 740 g
Performance on steel plate	~ 3 mm	~ 5 mm	~ 10 mm	~ 15 mm

Properties	Limit values
Explosive content (RDX, PETN)	88.0 ± 3.0%
Density	min. 1.48 g.cm ⁻³
Vacuum test	max. 1.0 cm ³ .g ⁻¹ .h ⁻¹ .20
Detonation velocity	min. 7,400 m.s ⁻¹
DMNB content	min. 1.0%



Semtex[®] PasteX 14

PASTE EXPLOSIVE

RDX and PETN based paste explosive for special blasting works.

Utilization of paste explosives proved to be especially advantageous in case of need to load them on hardly accessible places at demolition work. Packing in cartouches per 500g or tubes per 200g.

UN No.: 0084, explosive, blasting, type D, 1.1D



Properties	Limit values
Explosive content (RDX, PETN)	86.0 ± 2.0%
Density	min. 1.55 g.cm ⁻³
Vacuum test	max. 0.5 cm ³ .g ⁻¹ .h ⁻¹ .20
Detonation velocity	min. 7,600 m.s ⁻¹
DMNB content	min. 1.0%
Application temperature	-30 - +60 °C

FT-80

SILICONE ADHESIVE

Adhesive for fixing of charges on different surfaces.

Possibility of underwater application.

Wide range of application temperature.

Packing in cartouches à 330g.

No explosive content.



Properties	Limit values
Density	1.05 ± 0.10 g.cm ⁻³
Application temperature	-30 - +70 °C



BC 25

BREACHING FRAME

Means for rapid breaching through building barrier structures. Visually it resembles a clamshell suitcase equipped with a handle for transport and straps for carrying on the back. Inside there are several aluminium segments which allow the quick assembly of a supporting system for fixing the opened breaching frame to the barrier. Installation is done by putting the breaching frame to the barrier and fixing it at the necessary height using the supporting system. The frame can be initiated in a random corner by inserting a detonator into the initiation hole.



Basic data

Dimensions in transport conditions	545 x 540 x 145 mm
Total weight	13.5 ± 0.5 kg
Explosive weight	2.3-2.4 kg
Size of hole made	min.: 900 x 450 mm
	typ.: 1,000 x 500 mm
	concrete: 200 mm
Thickness of materials breached	brick: 300 mm
	hollow brick: 450 mm
	steel equivalent: 15-25 mm

DISINTEGRATOR

These are means intended to combat against terrorism – special blasting cartridges designed for the “opening” of suspicious luggage or items (suitcases, bags, drums, wooden boxes, etc.). A disintegrator uses the action of “mass cloud”, during which the energy of an explosion is transferred to the object by means of heavy powder material. A standard detonator is used to initiate the disintegrators. Disintegrators are offered in two versions.

DISINTEGRATOR 13

Is used for breaching of items/containers with a soft casing, such as cases, bags or backpacks from a distance of 10-80 cm. The charge contains 13 grams of Semtex plastic explosive.

DISINTEGRATOR 50

Is more powerful variant capable to breach harder containers, such as metal barrels or wooden boxes. It is able to breach steel plate with a thickness of up to 4 mm in distance 100 mm. The charge contains 50 grams of a Semtex plastic explosive.

A disintegrator does not usually initiate explosive materials like emulsions, ANFO, TNT, AN/TNT, RDX, Semtex from a distance greater than 200 mm.



IRTG

PLASTIC MASS

A plastic mass simulating plastic explosives containing hexogen or penthrite.

- **IRTG H 20 WG** - contains 20% of hexogen - yellow colour
- **IRTG P 20 WG** - contains 20% of penthrite - red brown colour

Usable for

- checking X-ray detectors of high explosives and training their operators
- checking chemical detectors of high explosives and training their operators
- training dogs in the detection of plastic explosives based on penthrite and hexogen

Classification:

ADR / RIC / IMDG: UN 3380, DESENSITIZED EXPLOSIVE, SOLID, N.O.S., 4.1 D

IT IS NOT NECESSARY TO STORE IT AS A HIGH EXPLOSIVE!



SET OF HIGH EXPLOSIVES SAMPLES

FOR TRAINING OF DOGS

Contains samples of Explosia a.s. production and other explosives:

- basic high explosives (TNT, PETN, RDX, HMX)
- detection agent (DMNB)
- ammonium nitrate, ammonite and emulsion explosives
- dynamites
- single and double-base propellants
- black powder

Samples à 5 g, 50 g or 500 g in PE packs inserted in separate closed glass tubes or bottles.

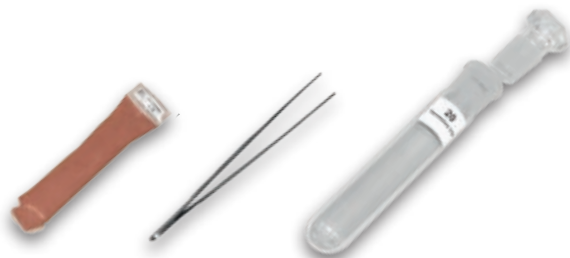

DEMONSTRATION SET OF HIGH EXPLOSIVES IN A NON-EXPLOSIVE VERSION

Contains imitations of Explosia a.s. production:

- industrial explosives
- plastic explosives
- special charges

The set is designed for police and military schools, police and military academies, military and police training of pyrotechnic units.

Packed in a case.



DETEX[®]

SET FOR DETECTION AND IDENTIFICATION OF HIGH EXPLOSIVES

DETEX[®] system is based on colour reactions of detection solutions with compounds as e.g. TNT, RDX, HMX, PETN, TETRYL or inorganic nitrates, chlorates and explosives based on organic peroxides (TATP, TCAP, HMTD), contained in dynamites, smokeless powders, plastic explosives, ammonites etc.

DETEX[®] system identifies industrial, military and improvised explosives, as nitroaromates, nitramines, organic nitroesters, inorganic nitrates and chlorates. DETEX[®] set consists of numbered bottles containing detection reagent solutions, wiping test papers for collecting samples and protective gloves.



EXPLOSIVE REACTIVE ARMOUR ELEMENTS FOR ARMoured VEHICLES

Components of the protection systems for T-55 and T-72 main battle tanks. Their construction ensures the needed effect even against the projectiles containing tandem shaped charges.





LARGE-CALIBRE AMMUNITION

155 mm BMCS

BI-MODULAR CHARGE SYSTEM FOR 155 mm GUN-HOWITZERS

Propelling charge system enables to cover ranges from 3 to 42km.

- Universal for all types of 155 projectiles
- In accordance with JBMoU
- Usable in systems with 45 & 52 cal. barrels or older 39 cal. (with max 5xTC-F)
- Temperature range from -50 °C to +63 °C
- Fully combustible cartridge case
- Waterproof
- Low wear of barrel
- Low muzzle flash
- Automatic or manual loading

Bi-Modular Charge System (BMCS) consists from 2 (two) charges differentiated by marking, by colors, by visible black stripe and by the shape of case.

- **BC-E** is used for low ranges (Zone 1-2)
- **TC-F** is used for high ranges (Zone 3-6)



155 mm 52 cal/24 dm³

ERFB/BT (44 kg) equi. L15A1/A2		BC-E	2xBC-E	3xTC-F	4xTC-F	5xTC-F	6xTC-F
Zone		1	2	3	4	5	6
Muzzle Velocity	m/s	315	470	560	690	817	945
Pressure (max.)	MPa	70	200	95	150	230	355
Range (max.)	km	8.0	13.0	15.5	20.0	24.5	>30.0
Overlap	%		min. 15	min. 30	min. 30	min. 30	min. 30

Maximum range with ERFB/BB (47 kg) is 42 km.

155 mm 45 cal/24 dm³

ERFB/BT (44 kg) equi. L15A1/A2		BC-E	2xBC-E	3xTC-F	4xTC-F	5xTC-F	6xTC-F
Zone		1	2	3	4	5	6
Muzzle Velocity	m/s	310	460	540	660	790	910
Pressure (max.)	MPa	70	200	95	155	230	355
Range (max.)	km	7.5	12.5	15.0	19.0	24.0	>29
Overlap	%		min. 15	min. 30	min. 30	min. 30	min. 30

Maximum range with ERFB/BB (47 kg) is 40 km.



	BC-E	TC-F
Diameter	158 mm	158 mm
Length	155 mm	177 mm
Modules can be connected	NO	6xTC-F
Type of powder	Single base	Triple base
Additives	YES	YES
Ignition	CBI+black powder	CBI+black powder
Weight of charge	1.9 kg	2.8 kg
Propellant weight	1,500 g	2,400 g
Shelf life	>15 years of storage in original intact containers (average temperature +25°C)	

COMPONENTS FOR ASSEMBLING OF FULL-COMBUSTIBLE PROPELLING CHARGES

We can supply all components for assembling of modular propelling charges:

- singlebase smokeless powders
- triplebase smokeless powders
- combustible parts
- ignition sets
- internal packages
- other supply components (flash reducers, decoppering agents, covering nitrofoils, ...)

Possible modifications upon agreement.

PROPELLING CHARGES FOR 152 mm GUN-HOWITZERS

P750

Propelling charge of the new long-range ammunition DNICZ for 152mm SpGH vz.70 DANA. Long-range ammunition DNICZ enables system DANA to reach ranges over 25 km without necessity of modifications on munition magazines or on autoloading system.

Propelling charge is filled with efficient triplebase (nitroguanidine) smokeless powder.

152 mm propelling charges

Single- and doublebase smokeless powders for full and reduced propelling charges. Small scale production of 152 mm propelling charges.

Possibility of verification on ballistic simulators directly at the company testing ground.



PROPELLING CHARGES

FOR 125 MM TANK GUNS

125mm APFSDS-T rounds

Small scale production of 125 mm APFSDS-T rounds for 2A46 tank guns - penetrator assembly needs to be delivered by customer.

Penetration capability more than 550mm RHA (more than 500 mm in distance 2000 m) - depends on delivered penetrator. Base propelling charge is filled with efficient double- or triple-base smokeless powders.

125 mm base propelling charges

Small scale production of base propelling charges for 125 mm tank guns (variants of 2A46 gun). Propelling charges for HE, HEAT and APFSDS rounds.

Single-, double- and triplebase smokeless powders for Z40CZ, Z52 and Z62 propelling charges and their small scale production.

Z40CZ, Z52 - propelling charges for HE and HEAT rounds.
Z62 - base propelling charge for APFSDS rounds.



COMBUSTIBLE MUNITION PARTS

Large scale production of combustibile munition parts for 155mm BMCS modular propelling charges.

Custom production of combustibile munition parts for modular propelling charges.

Small scale production of combustibile munition parts for base and carried propelling charges of 125mm tank gun ammunition.

Production of supplement charge containers for 120 mm mortar ammunition.

Produced by pressing of the sucked semi-finished products made from the nitrocellulose/pulp mixture.



COMBUSTIBLE CONTAINERS FOR MORTAR SUPPLEMENT CHARGES

Combustible cases of supplement charges for mortars of various calibers.

Production of supplement charge containers for 120 mm mortars.



ELEMENTS OF SOLID PROPELLANTS

FOR ROCKET MOTORS

Doublebase solid propellants.

Elements for rocket motors up to 105 mm diameter.

Used for:

- 122-JROF of 122mm salvo rocket launchers (GRAD systems)
- 122-KS Krizna - 122 mm container rocket for salvo rocket launchers
- Flight rocket motors for PG-9/PG-15 anti-tank ammunition
- Flight rocket motors for PG-7 and PG-7M anti-tank ammunition
- Flares

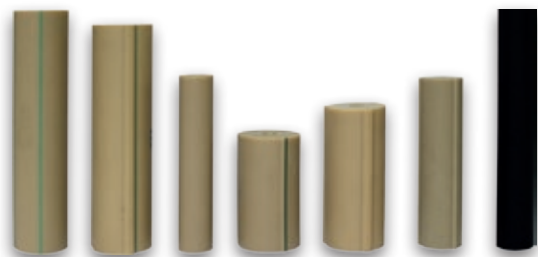

SMOKELESS POWDERS

FOR LARGE CALIBER AMMUNITION

Doublebase ribbon smokeless powders for Anti-tank ammunition propelling charges - PG-7(M)/PG-9/PG-15.

Ignition tubes for propelling charges.

Single- and doublebase smallgrain smokeless powders for training ammunition.





PYROTECHNICAL PRODUCTS

DynamEX

EXPANSION CARTRIDGE

Non-detonating pyrotechnical products for secondary blasting large pieces of rock, destruction of overhangs, demolition of steel-reinforced concrete constructions and destruction works in environments where, due to flying rock fragments, noise or seismic shock, classical blasting operations can not be performed using explosives.

The advantages of the use of expansion cartridges are:

- Dust reduction (no so much fine particles as when working with explosives)
- High safety of work (expansion cartridges only burn out or just burst when initiating outside a sealed borehole)
- Flying rock fragments reduction compared to blasting using explosives
- No shockwave vibration
- Reduction of noise and pressure waves in the air
- Less restrictive regulations for transport and use than the use of explosives

Classification for ADR transport

UN No.: 0432, pyrotechnic article for technical purposes, 1.4S



GAS-GENERATORS

FOR REGENERATION OF DRILLS

Gas-generators for regeneration of cased boreholes in the extraction of minerals (oil or solid minerals by extraction with acids, etc.).

Applicable to a depth of approx. 150m of water column.

Usable in boreholes with a diameter of 80 to 300mm.

type GGD T-12

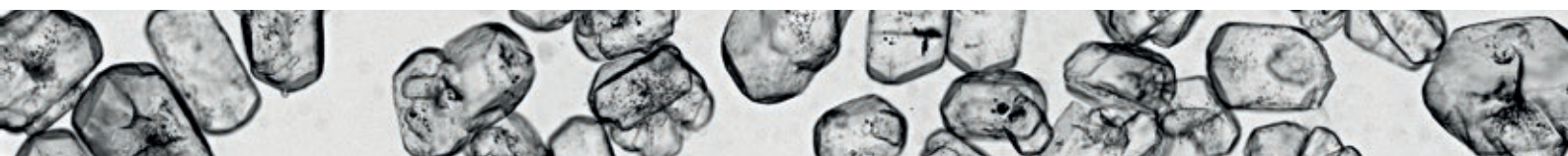
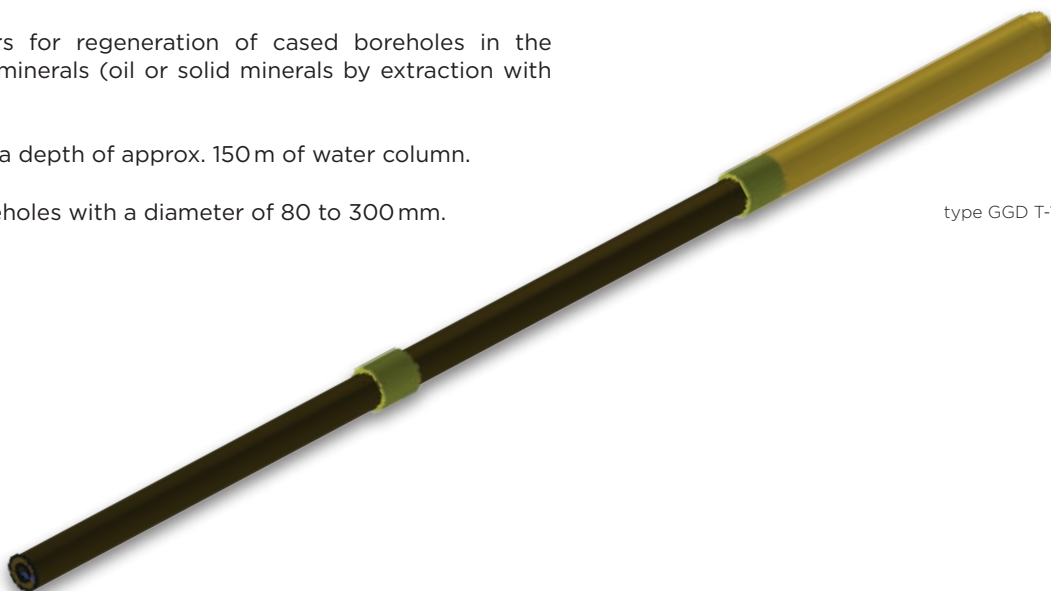

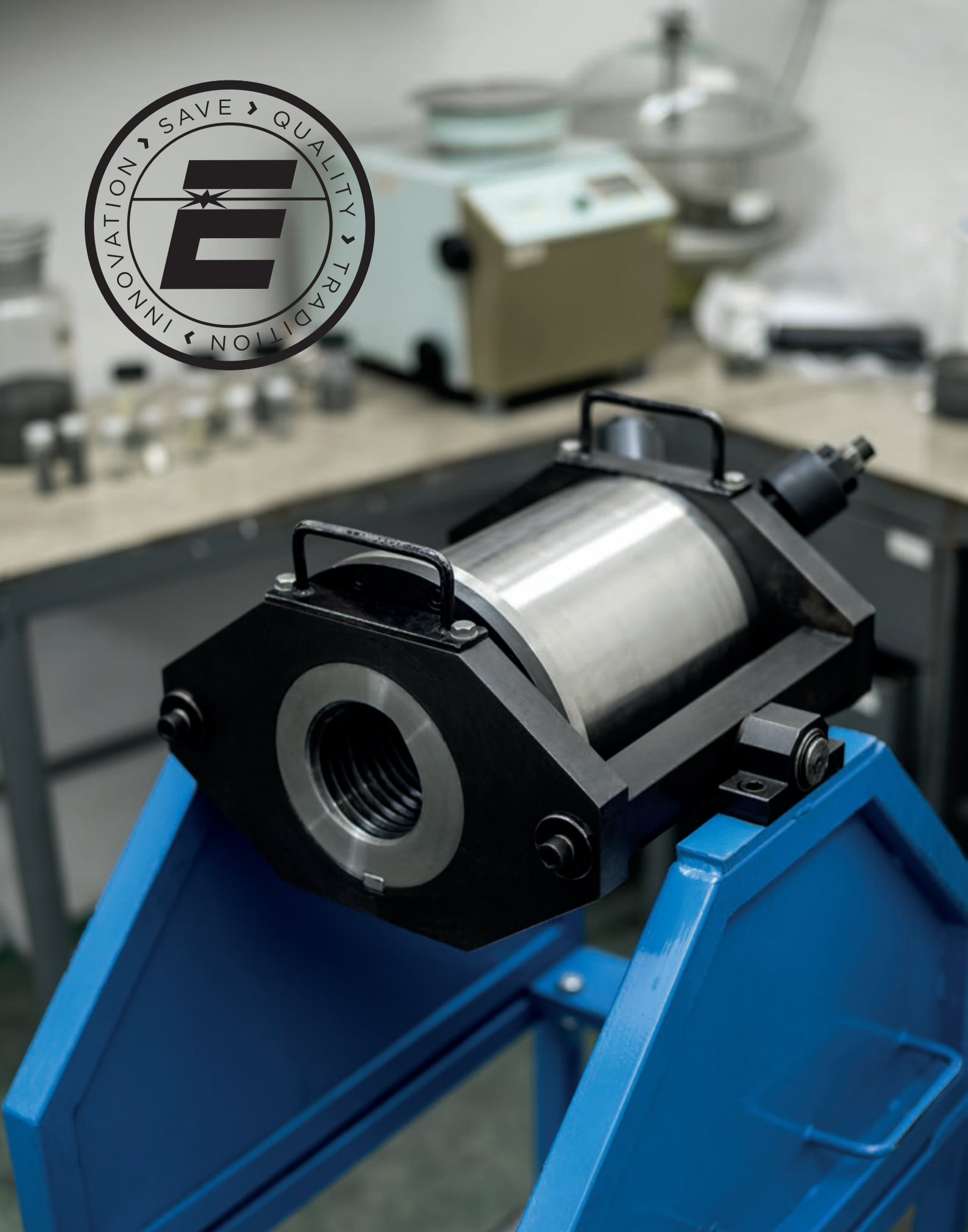

TESTING EQUIPMENT

CLOSED VESSEL

RB 40, 100, 200, 400 a 700

For measuring of pyrostatical parameters of propellants

Closed vessel RB is a part of pyrostatical testing measuring workplace. In combination with piezo-electrical pressure transducer it is used for measuring of pressure increase curve during burning of different propellant types in constant volume. From the values measured it is possible to obtain other information about the tested propellant using recording and evaluation device with special software. With high probability, the behaviour of the propellant tested at the shooting from real weapon can be predicted. Thus, by using of closed vessel the number of shots from real weapon is minimised. Data obtained from tests in closed vessel can be used at the development of new propellants and at the checking of regular powder types, too.

Closed vessel RB was developed in Research Institute of Industrial Chemistry, Explosia a.s., Pardubice, Czech Republic in cooperation with Faculty of Transport Engineering, University Pardubice within the project.

Device description

RB is high pressure closed vessel constructed from high strength steel with cooling jacket on the outer surface. It is equipped by temperature sensor, by piezo-electrical pressure transducer, by two outlet valves and by specially sealed breech screw. The breech screw is equipped by ignition device – either electrical, either mechanical. Closed vessel is settled in stand, which allows its position change and fixation in the range of 180°. Stand is fixed on mobile chassis with antistatic modification.

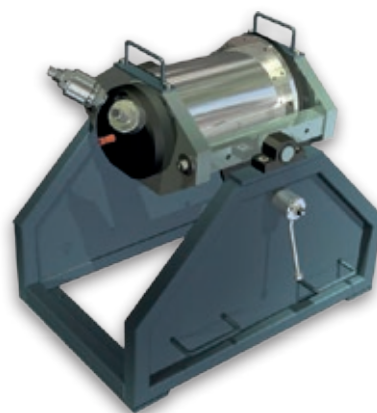
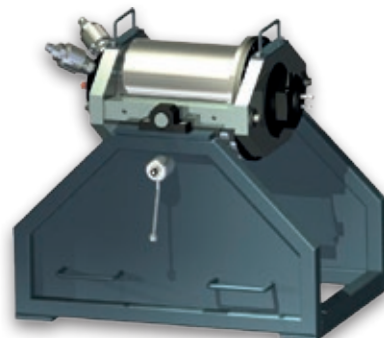

Properties

Volume	40, 100, 200, 400 or 700 cm ³
Volume	up to max. 500 MPa (5 000 bar) according to type of RB
Material	high strength steel
Loading density	usually 0.10–0.25 g.cm ⁻³ according to STANAG 4115
Ignition	electrical – for pressure up to 500 MPa (5000 bar) according to type of RB
	mechanical – for pressure up to 280 MPa (2800 bar)

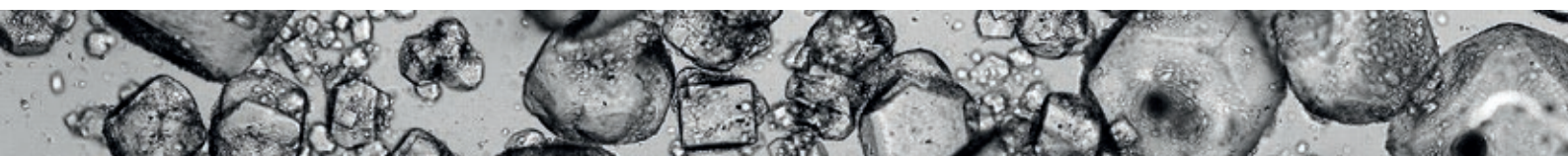



RESCUE SYSTEMS FOR AIRCRAFT

PYROTECHNIC COMPONENTS

FOR AIRCRAFT RESCUE SYSTEMS AERO



Rocket motor URM-1, URM-1M

- acceleration of pilot ejection seat on catapulting



Rocket motor ROP

- emergency ejection of aircraft cockpit canopy



Cartridge PP-POP

- activation of cockpit canopy ejection mechanism



Cartridge PP-TVM

- activation of telescopic ejection gun

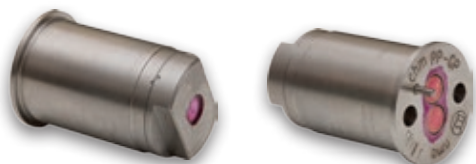

Cartridge PP-GP

- activation of pyromechanism of rescue system

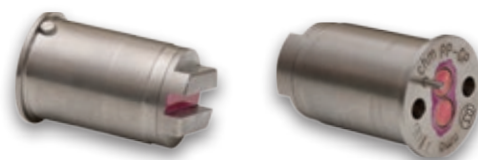

Cartridge PP-VVPR

- activation of pyromechanism of pilot fastening system



Cartridge VMP-2M(8)

- activation of rescue parachute gun





ACCREDITED SERVICES

ACCREDITED SERVICES

Explosia a.s. has the following testing laboratories:

- Ballistics Testing Laboratory
- Safety Engineering Laboratory
- GC/MS and IfLC Laboratory

Scope of the performed tests

No.	Test procedure/method name	Tested object
1.	Maximum pressure test of powder gases	Smokeless powders for weapons up to 30mm caliber (including)
2.	Test of projectile velocity	Smokeless powders for weapons up to 30mm caliber (including)
3.	Test of barrel pressure/time dependence	Smokeless powders for weapons up to 30mm caliber (including)
4.	Combined test of the electronic measurement of pressure, velocity and operating time	Smokeless powders for weapons up to 30mm caliber (including)
5.	Ballistic test - measurement of pull and pressure	Pressure generator Pull generator
6.	Determination of sensitiveness to hammer impact	Explosives, explosive substances
7.	Determination of sensitiveness to friction	Explosives, explosive substances
8.	Thermal stability test at 75 °C	Explosives, explosive objects
9.	Determination of mass explosion capability	Explosives, explosive objects
10.	Test of sensitivity to external fire	Explosives
11.	Determination of air temperature	Explosives
12.	Test of sensitivity to external heat stimulus - Koen tests	Explosives, explosive substances
13.	Test of sensitivity to 12m fall	Explosives, explosive objects
14.	Test of untight packaging	Explosives, explosive objects
15.	Quantitative determination of centralite I, centralite II, akardite II by gas chromatography/ mass spectrometry method	Smokeless powders
16.	Quantitative determination of nitroglycerine, diphenylamine, 2-nitrodiphenylamine by liquid chromatography method	Smokeless powders

Analytical laboratories provide also other nonaccredited analysis and stability tests of smokeless powders and explosives.



Explosia a.s.

Semtín 107
530 02 Pardubice
Česká republika

tel.: +420 466 825 774
e-mail: speciality@explosia.cz

www.explosia.cz

